



Labculture[®] G4

Class II Type B2 Biological Safety Cabinets

*The Most Advanced, Energy-efficient, Safe,
and Ergonomic Biosafety Cabinet in the World*



LABCULTURE® G4 (LB2 G4) CLASS II TYPE B2 CABINET,



USB Port

- Export Data Logging
- Software Update
- Wired data transaction to BMS



Zero Volt Relay Contact

- Free Relay Contact
- Exhaust Free Relay Contact

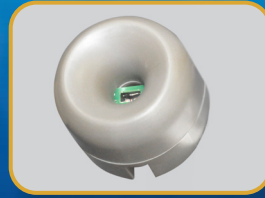

Airflow Sensor

- Monitors real-time airflow for safety
- Alert the user if airflow is insufficient

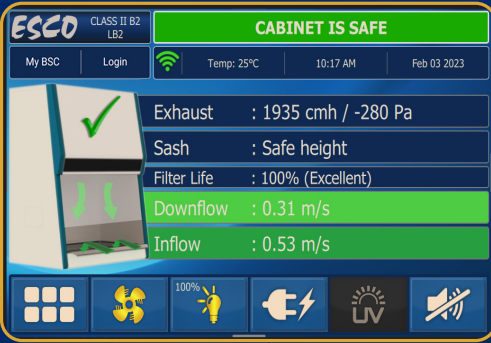

Centurion 7" Capacitive Touchscreen Controller

- Displays all safety information on one large screen
- Shows cabinet parameters with intuitive 3D illustration
- Easy to use menu, similar to Smart Phone Apps
- Large buttons, easy to operate when wearing gloves
- Self-guidance to users to deal with specific situations
- Centered and angled down for easy reach and viewing
- Optional: 21 CFR Part 11 Compliance



Single Piece Wall

- Easy to reach service fixtures and electrical outlets on sidewalls
- Large radius corners for easy cleaning



User-friendly Work Tray

- Largest useable area in the market
- Recessed to contain spillage
- Sloped perimeter for easy cleaning
- Large, easy to clean tray handle



Raised Arm Rest

- Prevent grille blocking
- Comfortable working posture
- Durable stainless steel construction



Ergonomic Work Zone

- 10° angle to optimize user comfort, reduce glare, and maximize reach into the work area
- Brightly illuminated with >1200 lux (111 ft. cd)
- Industry-leading dimmable LED for optimum work comfort
- Airtight seal port for cable/tube exit protected by a negative pressure side wall



Esco Labculture® G4 Class II Type B2 Biosafety Cabinet
Available in 3 feet, 4 feet, 5 feet, and 6 feet models.

FEATURING ADVANCED TOUCHSCREEN CONTROLLER

Energy-efficient DC ECM Blower

- The leading energy efficient Class II Type B2 Biosafety Cabinet in the world with 70% energy savings compared to AC motor
- Stable airflow despite building voltage fluctuations and filter loading

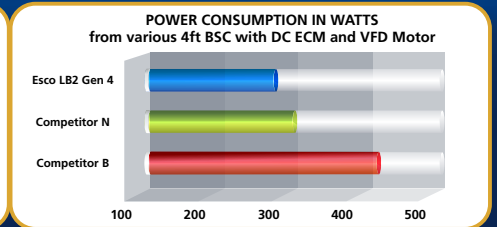
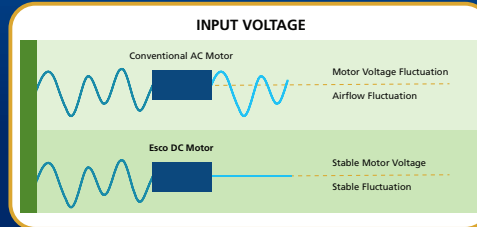

Advance Filtration System

- 10x Filtration efficiency of HEPA filter
- Creates ISO Class 3 work zone instead of industry-standard ISO Class 5
- Same 10 years filter life and replacement cost as HEPA filters
- LB2 G4 available in Bag-In Bag-Out System (BIBO) - integrated models.

Note:
 • 99.999% at 0.1 to 0.3 micron, ULPA as per IEST-RP-CC001.3 USA
 • 99.999% at MPPS, H14 as per EN 1822 EU



Dimmable LED

- Save energy and optimize work comfort

User Modified Pass-Through / Cable Port

- 3" Port with 1/4" hole on rubber membrane inside
- NSF-approved. Surrounded by negative pressure
- Allows cables and tubes to exit with fully closed sash

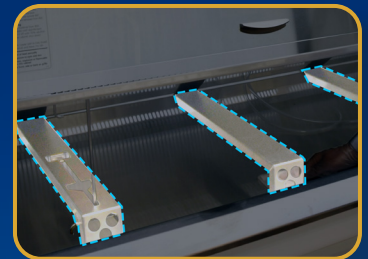

Tray Support Beams

- Support work tray evenly for less vibration
- Cleaning holder to easily wipe the drain pan

ISOCIDE™ Powder Coat

- Silver-ion impregnated powder coat
- Inhibits microbial growth to improve safety
- Prevents the plenum from becoming biohazard landfill

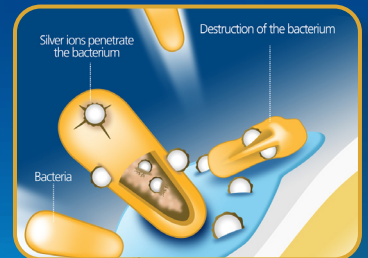

Certification

	Performance	Air Quality	Filtration	Electrical Safety
Standards Compliance	NSF / ANSI-49, USA	ISO 14644.1, Class 3, Worldwide US Fed Std 209E, Class 1 USA JIS B9920, Class 3, Japan	EN-1822 (H14), Europe IEST-RP-CC001, USA	UL 61010-1 3rd Ed, USA CSA22.2, No.1010-192, Canada

Dynamic Chamber™

- Blower plenum and side walls are surrounded by negative pressure
- Prevent contaminants from escaping outside

- Positive Pressure
- Negative Pressure

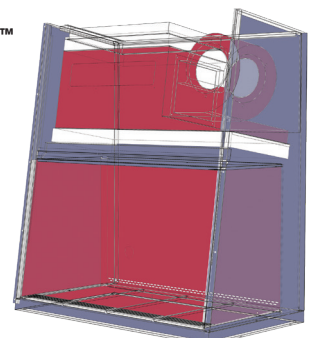

Cabinet Filtration System

- Ambient air is pulled through the front grille to prevent contamination of the work surface and work product. The inflow does not mix with the clean air within the cabinet work zone.
- Ambient air is taken in through a pre-filter at the top of the cabinet, and passes through the downflow ULPA filter, entering the work zone as laminar flow. The uniform, non-turbulent air stream protects against cross contamination within and throughout the work area.
- Near the work surface, the downflow air stream splits with a portion moving toward the front air grille, and the remainder moving to the rear air grille. A small portion of the ULPA filtered downflow enters the intake perforations at the side capture zones at a higher velocity (small blue arrows).
- A combination of inflow and downflow air streams forms an air barrier that prevents contaminated room air from entering the work zone, and prevents work surface emissions from escaping the work zone. The downflow combined with the inflow air enters the common air plenum.
- All air in the common plenum is HEPA-filtered and exhausted via a dedicated ducting system to the external environment.
- Fail-safe system ensures that in case of exhaust failure, the cabinet's main fan automatically shuts down to ensure safety to the user

The Performance Envelope Concept

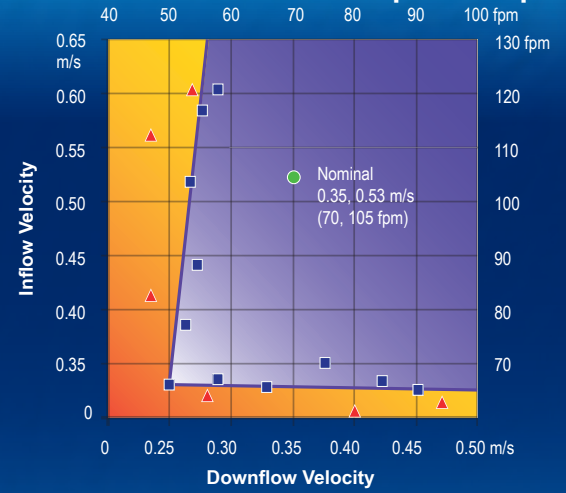

- Nominal Airflow
- Personnel / Product Protection
- Area of Personnel / Product Protection
- ▲ No Personnel / Product Protection
- Area of no Personnel / Product Protection

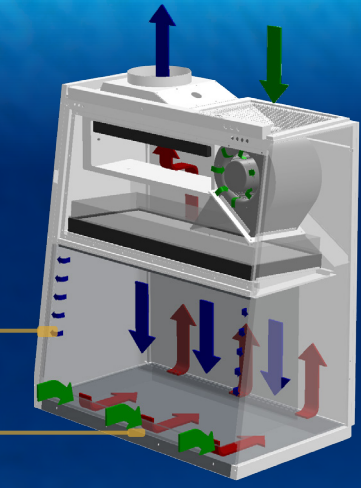

Dynamic air barrier, where inflow and downflow converge

Side capture zones

- ULPA-filtered air
- Unfiltered / potentially contaminated air
- Room air / Inflow air

Engineering Drawing

314 mm / 360 mm / 579 mm / 797 mm
(12.4" / 14.2" / 22.8" 31.4")

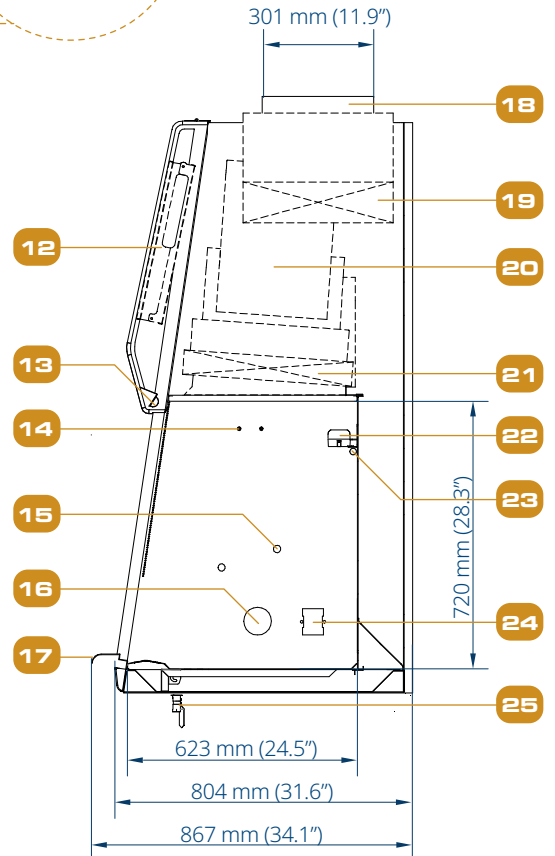
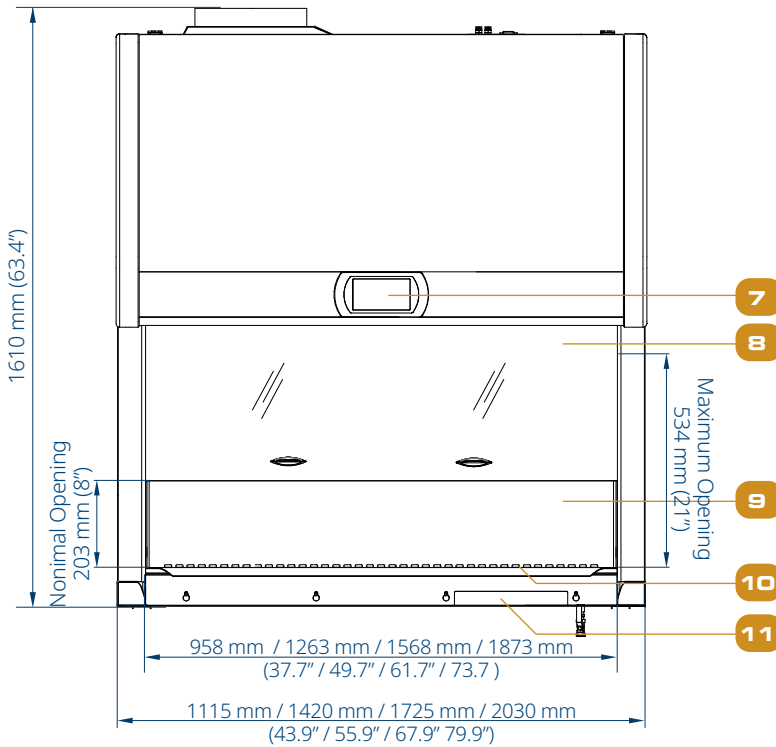
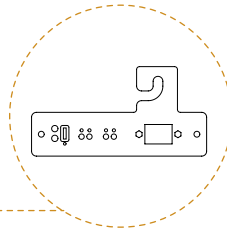
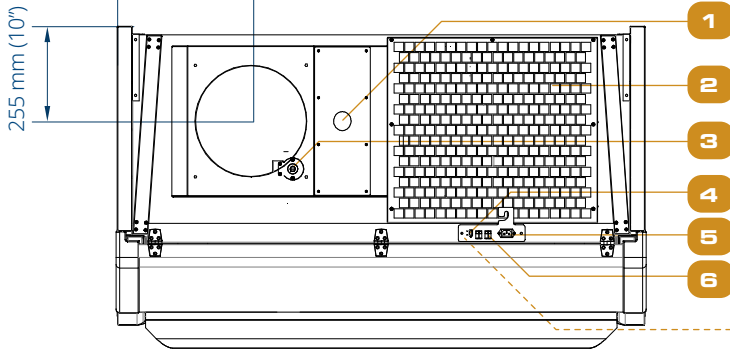

- VHP Out Provision (optional)
- Pre-filter
- Exhaust Airflow Sensor
- USB Port
- Power Inlet (single)
- Zero Voltage Relay Contact
- Centurion 7" Touch Screen Controllet

- Sash Glass
- Single-piece Stainless Steel Backwall
- Stainless Steel Work Tray
- Data Plate
- Electrical Panel
- Dimmable LED Lamp
- IV Bar Retrofit Kit Provision

- Service Fixture Retrofit Kit provision
- Cable Port (NSF Approved)
- Stainless Steel Armrest
- Exhaust Collar
- Exhaust Filter
- DC ECM Blower
- Downflow Filter

- Downflow Sensor
- UV Lamp Provision
- Electrical outlet
- Drain Valve (optional)

Class II Type B2 Biological Safety Cabinets (203 mm / 8" Opening)

TECHNICAL SPECIFICATIONS						
Labculture® Class II Type B2	Stainless Steel Side Walls	220-240 VAC, 50/60 Hz	LB2-3B8 G4 2011364	LB2-4B8 G4 2011365	LB2-5B8 G4 2011366	LB2-6B8 G4 2011367
		110-130 VAC, 50/60 Hz	LB2-3B9 G4 2011360	LB2-4B9 G4 2011361	LB2-5B9 G4 2011362	LB2-6B9 G4 2011363
Labculture® Class II Type B2 with BIBO		220-240 VAC, 50/60 Hz	LB2-3B8-BIBO G4 2011377	LB2-4B8-BIBO G4 2011378	LB2-5B8-BIBO G4 2011379	LB2-6B8-BIBO G4 2011380
		110-130 VAC, 50/60 Hz	LB2-3B9-BIBO G4 2011373	LB2-4B9-BIBO G4 2011374	LB2-5B9-BIBO G4 2011375	LB2-6B9-BIBO G4 2011376
Nominal Size			0.9 meter (3')	1.2 meter (4')	1.5 meter (5')	1.8 meter (6')
External Dimensions (W x D x H)	Without Optional Base Stand		1115 x 867 x 1610 mm (43.9" x 34.1" x 63.4")	1420 x 867 x 1610 mm (55.9" x 34.1" x 63.4")	1725 x 867 x 1610 mm (67.9" x 34.1" x 63.4")	2030 x 867 x 1610 mm (79.9" x 34.1" x 63.4")
Internal Dimensions (W x D x H)			958 x 623 x 720 mm (37.7" x 24.5" x 28.3")	1263 x 623 x 720 mm (49.7" x 24.5" x 28.3")	1568 x 623 x 720 mm (61.7" x 24.5" x 28.3")	1873 x 623 x 720 mm (73.7" x 24.5" x 28.3")
Usable Work Area			0.45 m ² (4.8 sq.ft.)	0.62 m ² (6.7 sq.ft.)	0.76 m ² (8.2 sq.ft.)	0.93 m ² (10.0 sq.ft.)
Sash Opening			203 mm (8")			
Maximum Sash Opening			534 mm (21")			
Average Airflow Velocity	Inflow		0.53 m/s (105 fpm)			
	Downflow		0.31 m/s (60 fpm)			
Airflow Volume	Inflow		376 m ³ /h (223 cfm)	493 m ³ /h (292 cfm)	608 m ³ /h (361 cfm)	724 m ³ /h (429 cfm)
	Downflow		628 m ³ /h (363 cfm)	822 m ³ /h (476 cfm)	1016 m ³ /h (588 cfm)	1210 m ³ /h (700 cfm)
	CBV Exhaust Air Volume*		1127 m ³ /h (658 cfm)	1476 m ³ /h (862 cfm)	1824 m ³ /h (1065 cfm)	2173 m ³ /h (1269 cfm)
	Minimum Exhaust Static Pressure		400 Pa / 1.6 in H ₂ O	375 Pa / 1.5 in H ₂ O	375 Pa / 1.5 in H ₂ O	400 Pa / 1.6 in H ₂ O
	CBV Exhaust Static Pressure*		575 Pa / 2.3 in H ₂ O	550 Pa / 2.2 in H ₂ O	550 Pa / 2.2 in H ₂ O	575 Pa / 2.3 in H ₂ O
Supply and exhaust ULPA Filter Efficiency			>99.999% at 0.1 to 0.3 micron, ULPA as per IEST-RP-CC001.3 USA			
			>99.999% at MPPS, H14 as per EN 1822 EU			
Sound Emission (dBA)**	NSF / ANSI 49		57 dBA	58 dBA	59 dBA	60 dBA
	EN 12469		54 dBA	55 dBA	56 dBA	57 dBA
Light Intensity	LED Lamp		≥1200 Lux (≥111 foot-candles)			
	Optional UV Lamp		253.7 nm			
Electrical Requirements*** (230V)	Nominal Power Consumption		128 W	174 W	207 W	230 W
	Heat Load		436 BTU/Hr	593 BTU/Hr	707 BTU/Hr	785 BTU/Hr
	Full Load Amps		9.5A	10A	10.5A	11A
Electrical Requirements*** (115V)	Nominal Power Consumption		160	167	202	225
	Heat Load		546 BTU/Hr	570 BTU/Hr	690 BTU/Hr	768 BTU/Hr
	Full Load Amps		13A	13.1A	13.2A	13.25A
Cabinet Construction	Main Body		Electro-galvanized steel with white oven-baked epoxy-polyester Isocide™ antimicrobial powder-coated finish, 1.5 mm (0.06") / 16 gauge thick			
	Work Zone		Stainless steel Type 304 with No.4 finish, 1.5 mm (0.06") / 16 gauge thick			
	Sash Window		6 mm UV-absorbing Tempered Glass			
Net Weight			279 Kg (615 lbs)	317 Kg (699 lbs)	359 Kg (791 lbs)	438 Kg (966 lbs)
Shipping Weight			318 Kg (703 lbs)	370 Kg (814 lbs)	402 Kg (886 lbs)	491 kg (1083 lbs)
Shipping Dimensions, Maximum (W x D x H)			1210 x 950 x 1950 mm (47.6" x 37.4" x 76.8")	1520 x 950 x 1950 mm (59.8" x 37.4" x 76.8")	1900 x 950 x 1950 mm (74.8" x 37.4" x 76.8")	2150 x 950 x 1950 mm (84.7" x 37.4" x 76.8")
Shipping Volume Dimensions (W x D x H)			2.24 m ³ (79.1 cu.ft.)	2.82 m ³ (99.6 cu.ft.)	3.52 m ³ (124.3 cu.ft.)	3.98 m ³ (140.6 cu.ft.)

Disclaimer: Technical Specifications may be subjected to further changes without further notice.

*This Concurrent Balance Value (CBV) Exhaust Volume (per Pitot Duct Traverse) and Static Pressure at cabinet exhaust connection should be used when sizing the HVAC exhaust and supply.

**Noise reading in open field condition / anechoic chamber. Noise reading in normal room varies by room size, layout, and background noise, but may reach roughly 3-4 dBA above these values.

***Electrical power consumption is an measurement of new unit with clean filter operated within nominal setpoint. Result per unit may vary.

Options and Accessories

Anti-blowback Valve 10 inches	EG Powder-Coated	ANTI-BLOW BACK VALVE 12" ABBV-12P (5170353)			
	304 Stainless Steel	ANTI-BLOW BACK VALVE 12" ABBV-12S (5170355)			
Inlet Collar LB2-A		ICO-LB23 5170320	ICO-LB24 5170263	ICO-LB25 5170316	ICO-LB26 5170322
Prefilter, 565 X 500mm	PF-2 (5090001)				
UV Lamp		UV-15A-L (5170251)	UV-30A-L (5170255)		
IV Bar		IV-955 (5170276)	IV-1260 (5170277)	IV-1565 (5170278)	IV-1870 (5170279)
Electrical Outlet	Direct Mounted	EO- _			
	GFCI	EO-GFCI 5170071			
Service Fixtures	EU SF-Gas-40 mm	SF-1G40 (5170002)			
	EU SF-Vacuum-40 mm	SF-1V40 (5170003)			
	EU SF-Air-40 mm	SF-1A40 (5170006)			
	EU SF-Nitrogen-40 mm	SF-1N40 (5170011)			
	EU SF-Water-40 mm	SF-1W40 (5170017)			
	SF-Nitrogen/Gas/Vacuum-40 mm	SF-2U40 (5170018)			
	Copper Piping for SF	CU-Pipe (5170026)			
Support Stand (705 to 915 mm with 50 mm increment / 28.0" to 36.0" with 2" increment, combination of caster wheels and leveling feet with lock)		STA-3A0 5131340	STA-4A0 5131341	STA-5A0 5131427	STA-6A0 5131389
VHP-OUT PORT KIT WITH COVER	5171398	5171397			
Top Decon Cover W/VHP	ALL SIZE LB2 G4 (5171399)				
Front Decon cover with VHP IN PORT	5171341	5171342	5171343	5171344	
Drain Valve	5142493				
Anti Blowback Valve (EG Powder Coated)	ABBV-12P (5170353)				
Manual Volumetric Exhaust Damper 12"	Damper 12" (5170105)				
Stainless Steel Pipette Storage Shelf	5260327				
Arm Rest Padding	MEWREST (5170127)				
Foot Rest	FT-REST (5170073)				
Laboratory Chair	ME-LD-AR360 (1150006)				
IQQQ Protocol	9010179				



ABBV_

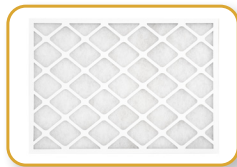

PF-2_



UV- A-L

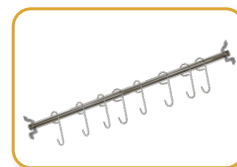

IV_



EO-H_

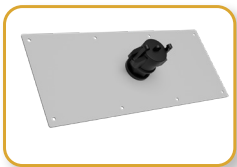

VHP OUT

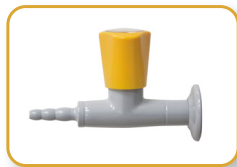

SF-1_



SF-2U_



STA_



SS Pipette Storage Shelf



MEWREST



FT-REST



ME-LD-AR360



IQQQ

ESCO

LIFESCIENCES GROUP

Improving Lives Through Science

**DIRECT
MANUFACTURER**



- Animal Research Workstation
- Biosafety Safety Cabinet
- CO₂ Incubator
- Ducted Fume Hood
- Ductless Fume Hood
- Filtered Storage Cabinet
- Laboratory Centrifuge
- Laboratory Oven and Incubator

- Laboratory Refrigerator and Freezer
- Laboratory Shaker
- Laminar Flow Cabinet
- PCR Cabinet
- PCR Thermal Cycler
- Powder Weighing Balance Enclosure
- Ultra-low Temperature Freezer

ESCO

LIFESCIENCES

- Airflow Containment
- Cross-Contamination Facility Integrated Barrier
- Isolation Containment
- Ventilation Containment
- Radiopharmacy

- Adherent Cell Bioreactors
- Adherent Automated Cell Harvesting System
- Cell Culture Monitoring Tools
- Single-use Consumables for Bioprocessing



ESCO

MEDICAL

- Time-Lapse Incubator
- Benchtop Incubator
- ART Workstation
- CO₂ Incubator
- Anti-Vibration Table
- Gas Analyser

ESCO

ASTER

CRDMO Services



ESCO LIFESCIENCES GROUP

42 LOCATIONS IN 21 COUNTRIES ALL OVER THE WORLD



- 📍 Global Offices
- Distributors
- Factories
- R&D Centers
- Regional Distribution Centers

Follow us on social media, download our apps,
and scan the QR code for more info.



@EscoSifesciences



@EscoSifesciences



@EscoSifesci



@EscoS



@EscoSifesciences



@EscoSifesciences



EscoS Lifesciences



EscoS Lifesciences

ESCO

LIFESCIENCES GROUP

EscoS Micro Pte. Ltd. • 19 Changi South Street 1 • Singapore 486779
Tel +65 6542 0833 • mail@escosifesciences.com
www.escosifesciences.com

EscoS Technologies, Inc. • 903 Sheehy Drive, Suite F, Horsham, PA 19044, USA
Tel: +1 215-441-9661 • eti.admin@escosifesciences.com

EscoS Lifesciences Group Offices: Bangladesh | China | Denmark | Germany | HongKong | India | Indonesia | Italy | Japan | Lithuania
| Malaysia | Myanmar | Philippines | Russia | Singapore | SouthAfrica | South Korea | Taiwan | Thailand | UAE | UK | USA | Vietnam